

REVISIONS		
REV. NO.	DESCRIPTION	DATE

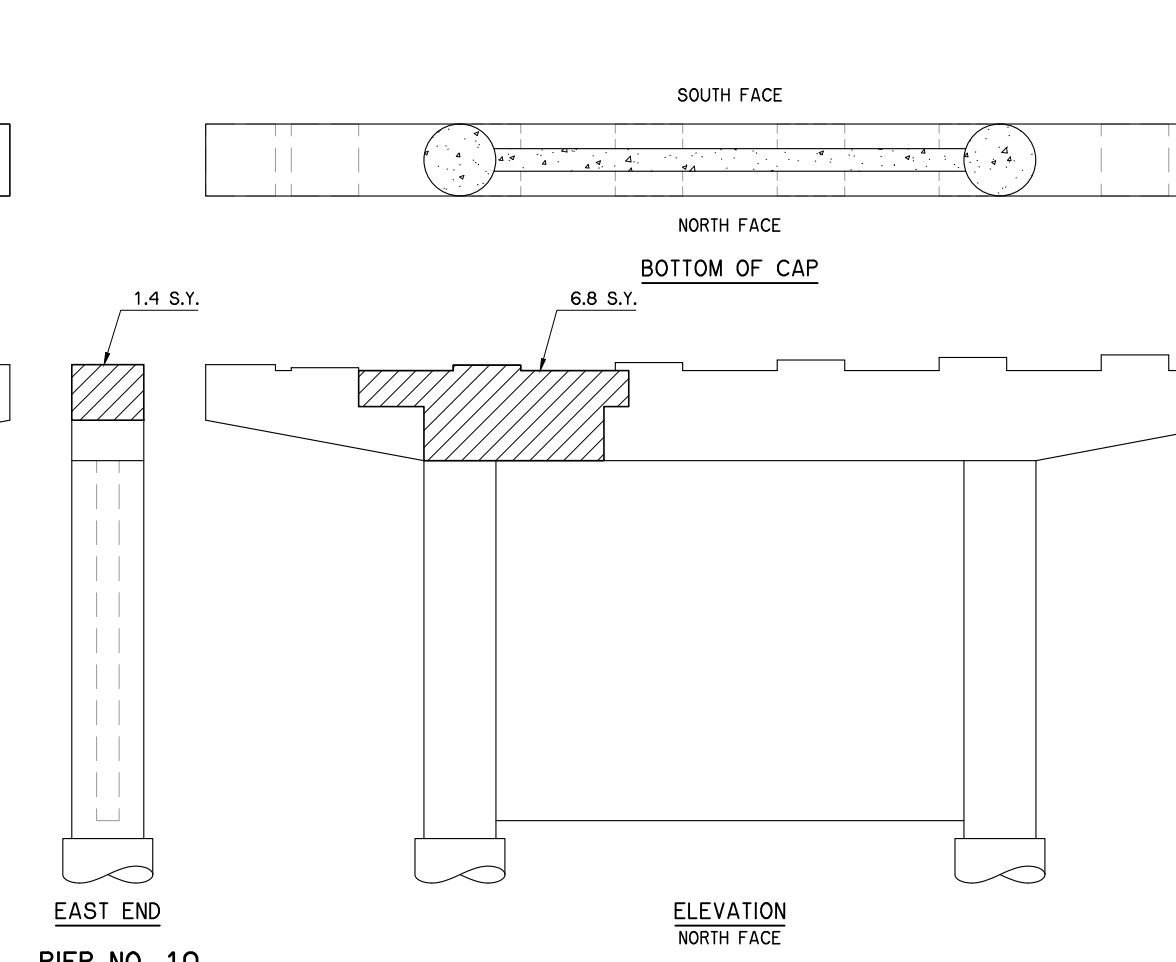
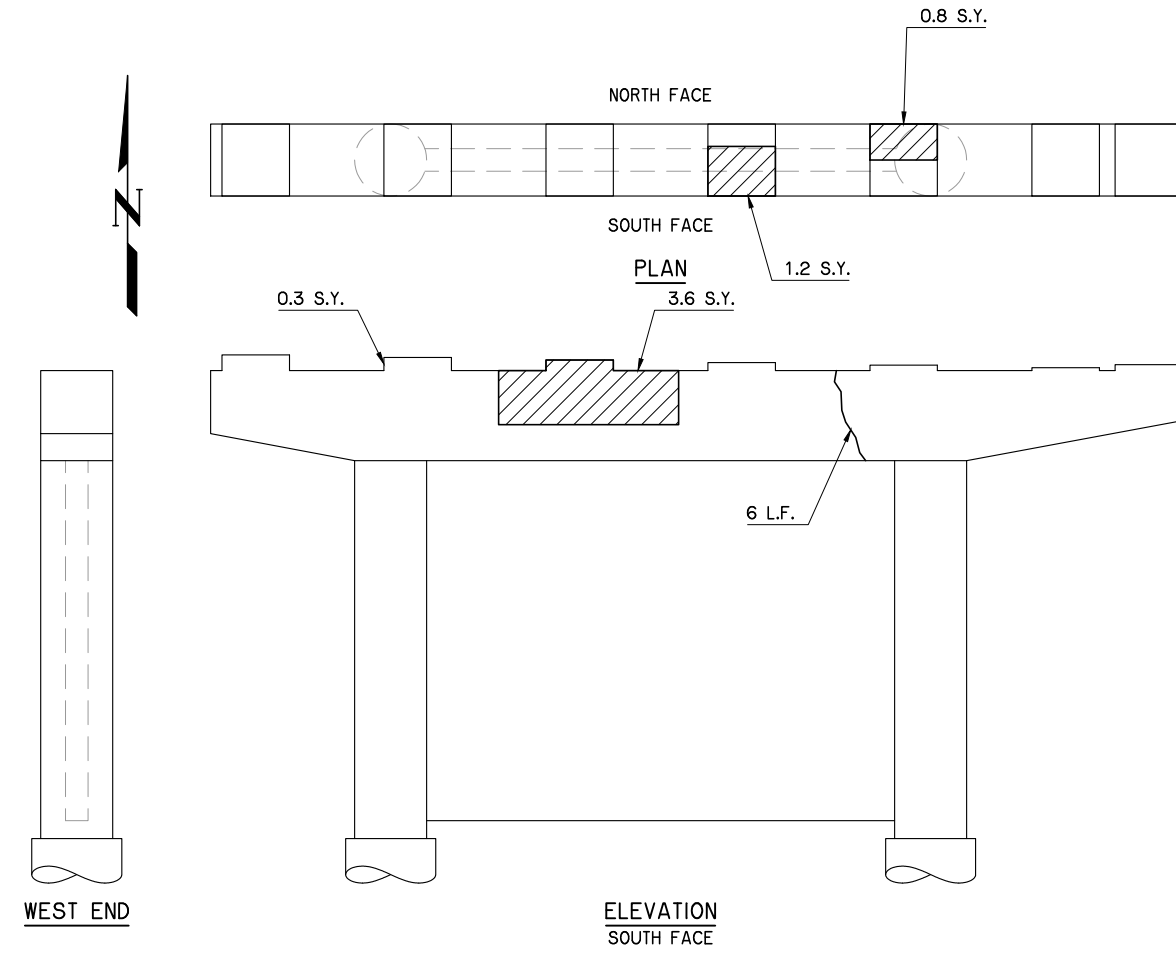
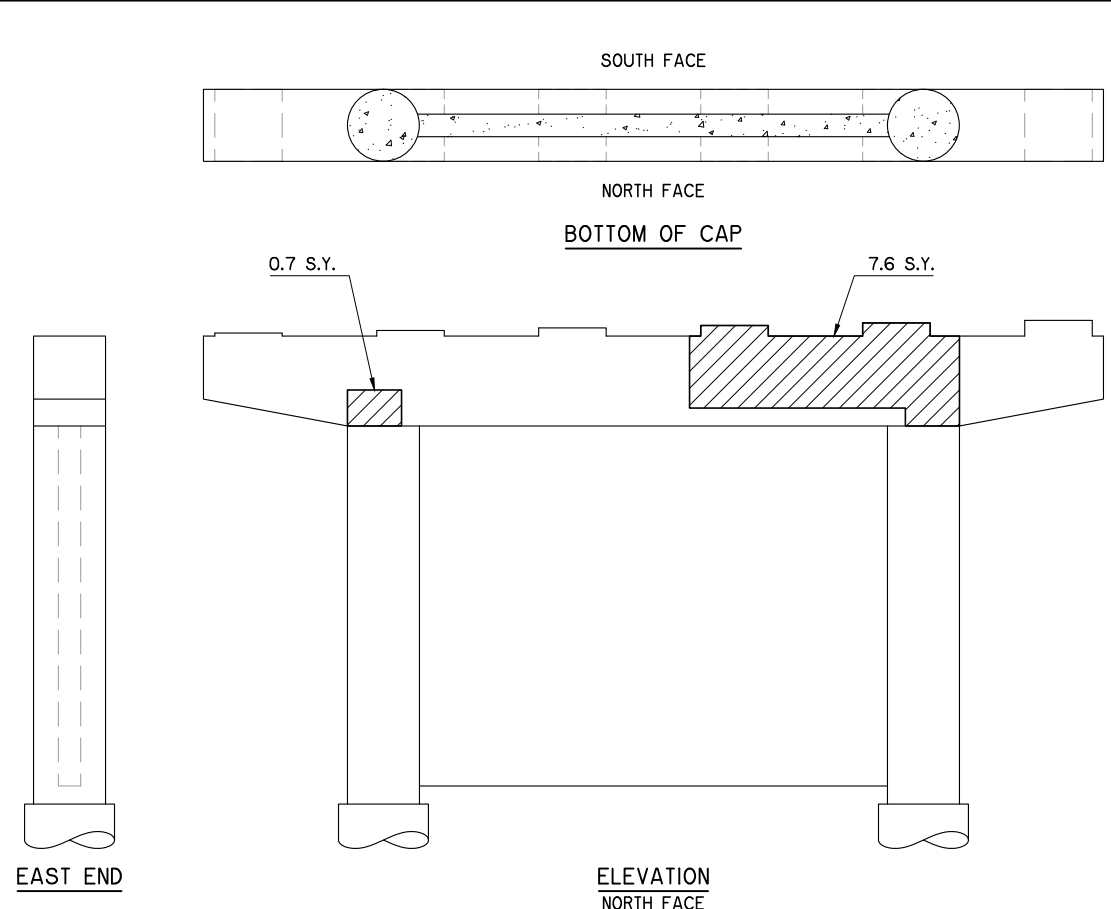
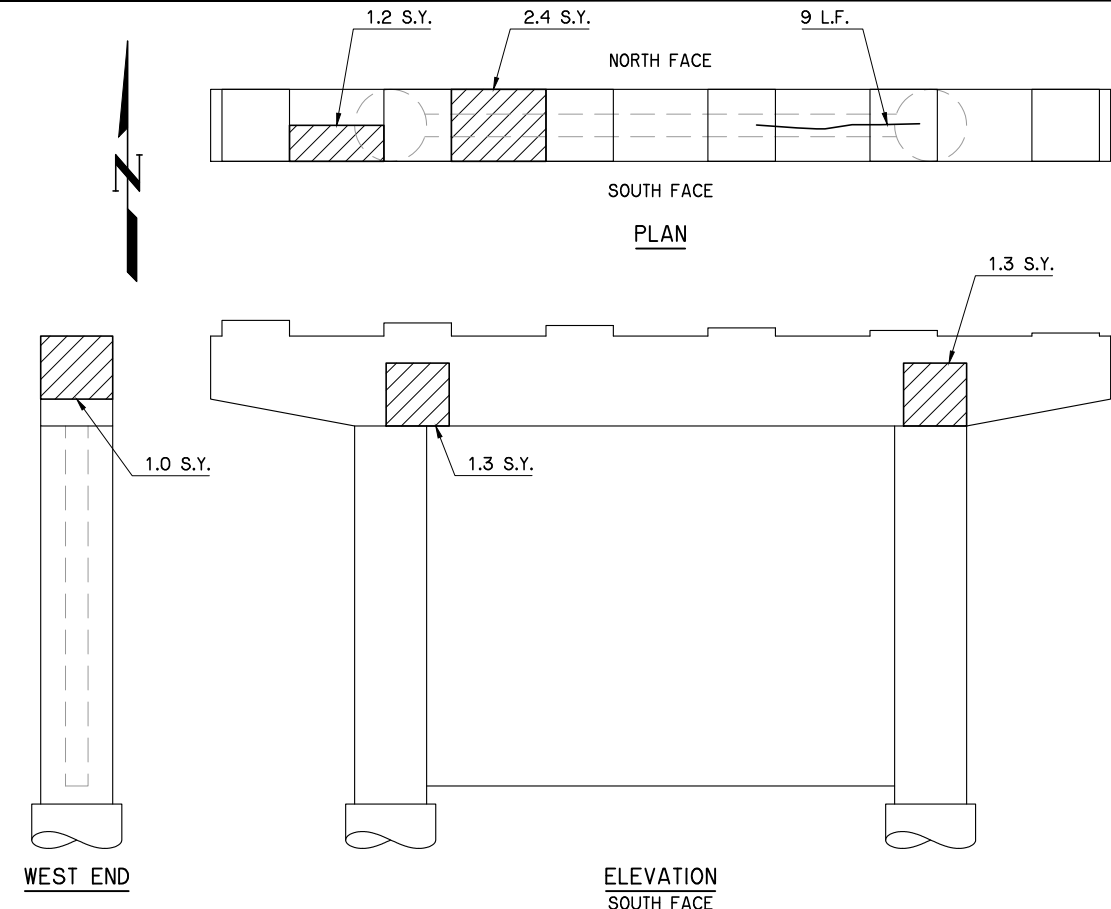

**LEGEND**

	PREPARATION OF CRACKS (ABOVE WATER)
	REPAIR BRIDGE ITEMS

I:\Active\1626\Drawings\17 Pier 9 & 10.dwg, 6/12/2017 11:11:42 AM, Fred

SH 51 NB OVER ARKANSAS RIVER	TULSA COUNTY	Design	ADT
PIER REPAIR DETAILS PIER NO. 9 AND NO. 10		Detail	FEZ
		Check	ADT
STATE OF OKLAHOMA		WHITE ENGINEERING ASSOCIATES	
DEPARTMENT OF TRANSPORTATION		SHEET NO. 17	
JOB PIECE NO. 31358(04)			